

INSTRUCTION MANUAL

C-BOX V1.6.5

Smart Processing Interface
For MS-90

C-Box Modbus 485

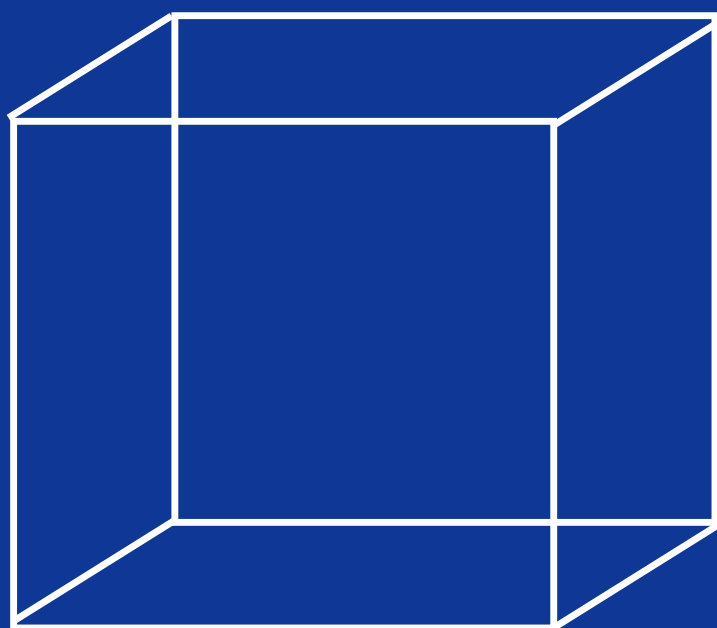

EKO

1. Index

1. Index	1
2. Important User Information	2
2-1. Contact Information	2
2-2. Warranty and Liability	2
2-3. About Instruction Manual	3
2-4. Environment	3
2-5. CE Declaration	4
3. Safety Information	5
3-1. WARNING/CAUTION	5
4. Introduction	6
4-1. Package Contents	6
5. Getting Started	7
5-1. Parts Name	7
5-2. System Overview	7
5-3. Installation	8
5-4. Settings	8
5-5. Operating	10
5-6. Irradiance measurements	10
6. Modbus communication	12
6-1. Communication	12
6-2. Registers	13
6-3. Software	14
7. Specification	16
7-1. Main Unit	16
7-2. Dimensions	17
Appendix	18
Appendix -A.	
Wiring table C-Box	18

2. Important User Information

Thank you for using EKO Products

Make sure to read this instruction manual thoroughly and to understand the contents before starting to operate the instrument. Keep this manual at safe and handy place for whenever it is needed.

For any questions, please contact us at one of the EKO offices given below:

2-1. Contact Information

EKO INSTRUMENTS CO., LTD.

Asia, Oceania Region

www.eko-asia.com	EKO INSTRUMENTS Co., Ltd.	Tel: +81 (3) 3469-6713
info@eko.co.jp	1-21-8 Hatagaya, Shibuya-ku	Fax: +81 (3) 3469-6719
	Tokyo, 151-0072 Japan	

Europe, Middle East, Africa, South America Region

www.eko-eu.com	EKO INSTRUMENTS Europe B.V.	Tel: +31 (0)70 3050117
info@eko-eu.com	Lulofsstraat 55, Unit 28,	Fax: +31 (0)70 3840607
	2521 AL, Den Haag, The Netherlands	

North America Region

www.eko-usa.com	EKO INSTRUMENTS USA Inc.	Tel: +1 408-977-7751
info@eko-usa.com	95 South Market Street, Suite 300	Fax: +1 408-977-7741
	San Jose, CA 95113 USA	

2-2. Warranty and Liability

For warranty terms and conditions, contact EKO or your distributor for further details.

EKO guarantees that the product delivered to customer has been verified, checked and tested to ensure that the product meets the appropriate specifications. The product warranty is valid only if the product has been installed and used according to the directives provided in this instruction manual.

In case of any manufacturing defect, the product will be repaired or replaced under warranty. However, the warranty does not apply if:

- Any modification or repair was done by any person or organization other than EKO service personnel.
- The damage or defect is caused by not respecting the instructions of use as given on the product brochure or the instruction manual.

2-3. About Instruction Manual

Copy Rights Reserved by EKO Instruments Europe B.V. Making copies of whole or parts of this document without permission from EKO is prohibited.

This manual was issued: 2021/01/04

Version Number: 1.6.4

2-4. Environment

1. WEEE Directive 2002/96/EC

This product is subjected to WEEE Directive 2002/96/EC and should not be mixed with general household waste. For proper treatment, recovery and recycling, please take this product(s) to a designated recycle collection point.

Disposing of this product correctly will help save valuable resources and prevent any potential negative effects on human health and the environment, which could otherwise arise from inappropriate waste handling.

2. RoHS Directive 2002/95/EC

EKO Instruments has completed a comprehensive evaluation of its product range to ensure compliance with RoHS Directive 2002/95/EC regarding maximum concentration values for substances. As a result all products are manufactured using raw materials that do not contain any of the restricted substances referred to in the RoHS Directive 2002/95/EC at concentration levels in excess of those permitted under the RoHS Directive 2002/95/EC, or up to levels allowed in excess of these concentrations by the Annex to the RoHS Directive 2002/95/EC.

2-5. CE Declaration



IMPORTANT USER INFORMATION



DECLARATION OF CONFORMITY

We: EKO Instruments Europe B.V.
Lulofsstraat 55, U 28, Den Haag
2521 AL Den Haag

The Netherlands

Declare under our sole responsibility that the product:

Product Name : Control box for the MS-90 DNI sensor
Model No. : C-BOX

To which this declaration relates is in conformity with the following
harmonized standards of other normative documents:

Harmonized standards:

EN 61326-1:2006 Class A (Emission)
EN 61326-1:2006 (Immunity)

Following the provisions of the directive:

EMC-directive : 89/336/EEC
Amendment to the above directive : 93/68/EEC

Date : 01-02-2020

Position of Authorized Signatory : Technical Director

Name of Authorized Signatory : C.H. Hoogendijk

3. Safety Information

EKO Products are designed and manufactured with consideration for safety; however, please make sure to read and understand this instruction manual thoroughly to be able to operate the instrument safely in the correct manner.



WARNING CAUTION

Attention to user; pay attention to the instructions given on the instruction manual with this sign.



3-1. WARNING/CAUTION

1. Installation

- Do not install C-BOX in a place, which it may get under water.
- Make sure the instruments are installed in a location where they are easily accessible for maintenance, or it may lead to unexpected accidents and injury.
- Although this product is designed to meet EMC Directive compliance requirements, it may not fully satisfy its primary specification/performance when using this product near following locations where strong electromagnetic wave is generated. Please pay attention to the installation environment.

Outdoor: High voltage power line, power receiver/distribution facility, etc.

Indoor: Large-size chiller, large rotation device, microwave, etc.

2. Power Supply

- Always make sure to check the power supply voltage and type (AC/DC) before connecting and powering ON the instruments.
- Use with fuse 0.5A connected in series on the power supply cable. Depending on the power supply connected, large current may flow when the internal malfunction occurs, and may lead to generating heat and fire.

3. Instruction Manual

- In this instruction manual contains basic and important operation information for the use of the C-BOX for the MS-90 DNI sensor and MS-90 plus+ system.
- Read this instruction manual and understand the contents well before operating C-BOX.
- Also, keep this instruction manual in handy location in case you need it.

4. Introduction

The C-BOX smart processing interface provides different functions for sensor control and data processing of different EKO sensors. In combination with the MS-90 DNI sensor, the pulsed output can be converted into a Modbus 485 RTU signal.

The **C-Box Modbus 485** has a built in GPS receiver and is used as part of the MS-90 Plus+ sensor system. By using this device, the MS-90 analogue output pulse is converted to digital. With an additional MS-80S or MS-80M Smart pyranometer a turnkey system can be configured to measure DNI, GHI and DHI over Modbus.

With Modbus 485 communication, it is possible to connect with PV monitoring devices or datalogger, which have a RS-485 serial interface and provide MODBUS serial communication.

The signal converter is integrated in an IP65 enclosure for outdoor installation. The settings for the measurements and communication can be changed by using the EKO C-Box setup software.

4-1. Package Contents

Check the package contents first; if any missing item or damage is noticed, please contact EKO immediately.

Table 4-1 Package Contents

Standard Items	Qty.	Remarks
C-BOX Main Unit	1	C-BOX-Modbus 485 with GPS
Cable	1	Standard Length: 10m for communication and power supply
Quick Start Guide	1	Contains Factory settings
MS-90 DNI Sensor, 1.5m cable	1	Optional item (Order with MS-90)
MS-80S GHI Sensor, 1.5m cable	1	Optional item (Order with MS-80S)

5. Getting Started

5-1. Parts Name

Each part name and its main functions are described below.

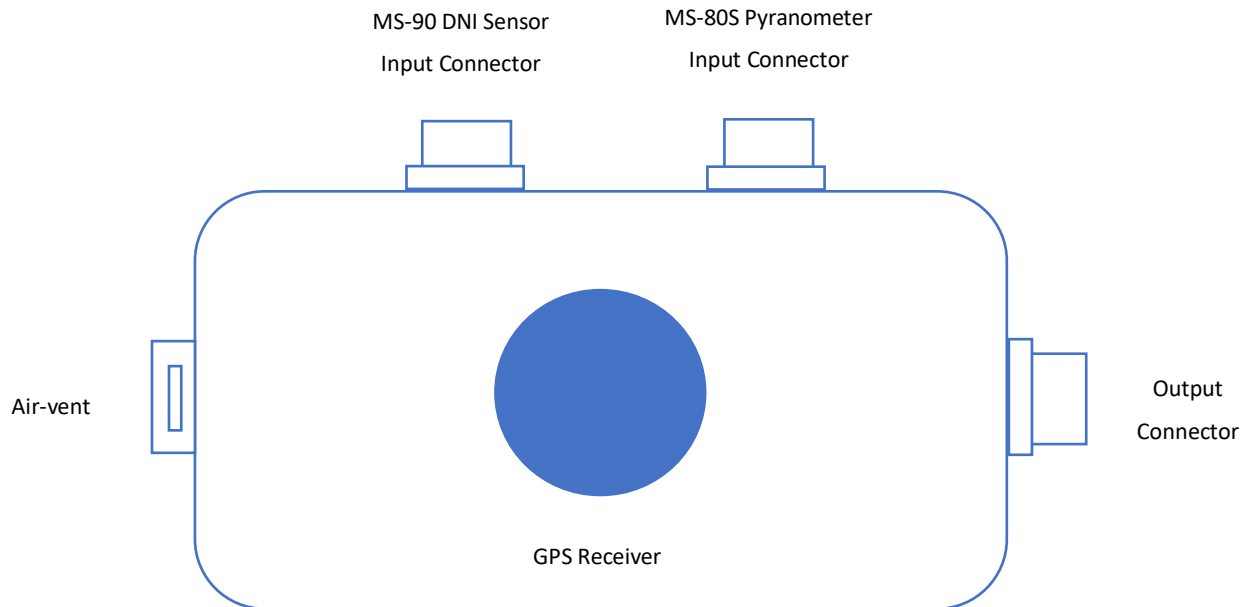

5-2. System Overview

The C-BOX Smart Processing Interface is used to build a sensor system to measure multiple irradiance components. Below figure describes the system overview of C-BOX.

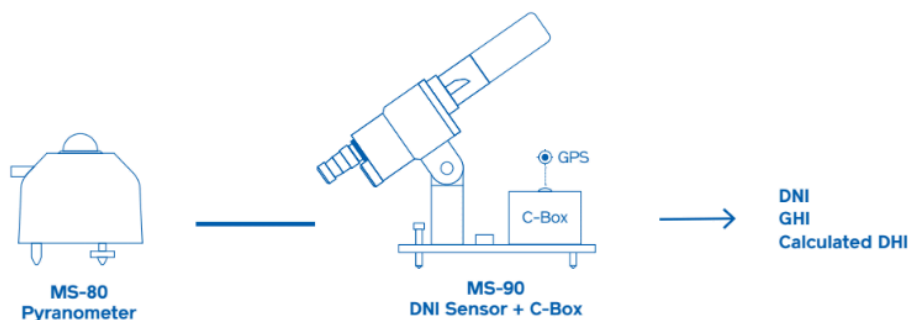

Figure 5-2-1. C-BOX system (sensors MS-90 and 80S are optional)

5-3. Installation

The ideal mounting position is a place without any obstructions such as buildings, trees, and mountains, however it might be difficult to find such location. As a general rule the sensors should have a clear horizon above 5°. The setup location should be easily accessible for periodic maintenance of glass dome cleaning, desiccant replacement, etc. Avoid surrounding towers, poles, walls or billboards with bright colors that can reflect solar radiation onto the sensors.

For is installation of the sensors MS-90 DNI sensor and MS-80S pyranometer check out the online manuals at EKO-EU.com.

5-4. Settings

1. Wiring

Connect all cables to the sensors and data acquisition system.

1. Connect the C-BOX to data logger via Modbus 485 RTU
2. Connect the Main Unit power supply
3. Connect the MS-90 DNI sensor signal cable to the sensor and C-Box
4. Connect the MS-80S Pyranometer signal cable to the sensor and C-Box

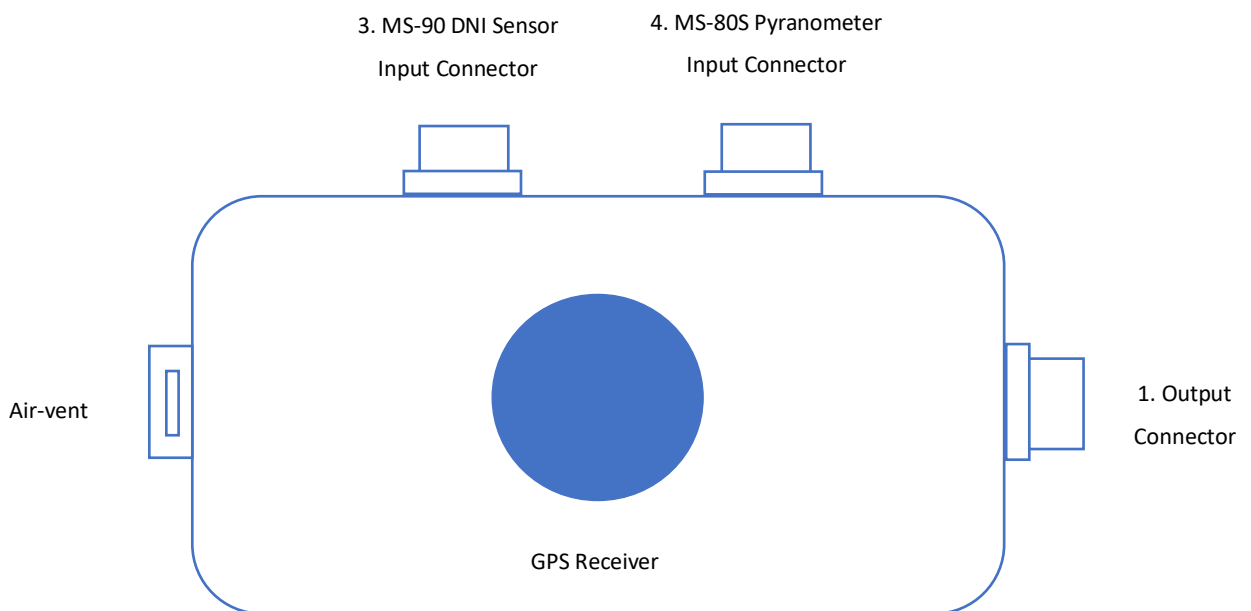

2. Connections

To extend the cable lifetime, prevent that the cables are not directly exposed to direct sun light or rain/wind. Cables can be placed in a cable conduit. Cable vibrations will potentially cause noise in the output signal. Fasten the cable so that the cable does not swing or move by wind blowing. Exposure of the signal cable to excessive electromagnetic emissions can cause noise in the output signal as well. Therefore the cable should be lined at a safe distance from a potential source generating EMC noise, such as an AC power supply, high voltage lines or telecom antenna.

Input MS-80S and MS-90

Table 5-4-1. Internal connections MS-80S / 90 to C-BOX

Terminals	Function
1. Shield	Not used
2. Shield	Not used
3. 0V	MS-80S (White)
4. 24 VDC Out	MS-80S (Brown)
5. Modbus B	MS-80S (Black)
6. Modbus A	MS-80S (Blue)
7. Modbus GND	MS-80S (Grey)
8. Reserved	Not used
9. MS-80 (+) Analog	Disabled
10 MS-80 (-) Analog	Disabled
11. MS-90 DNI (+)	MS-90 (Brown)
12. MS-90 DNI (-)	MS-90 (White)
13. 0V	Not used
14. 0V	Not used
15. 12VDC Out MS-90	MS-90 (Blue)
16. 0VDC Out MS-90	MS-90 (Black)

Output Modbus 485 RTU

Table 5-4-2. Connections C-BOX-Modbus 485 (Output)

5 Pin connector / wire Color	Function
1. Brown	24V Supply voltage
2. White	Supply voltage ground
3. Blue	Modbus (+) / A (RTU)
4. Black	Modbus (-) / B (RTU)
5. Grey	NC

C-BOX can connect to a system that communicates with Modbus 485 RTU. Connection of C-BOX to the RS-485 communication network is shown below. The Master represents the data-logging device [such as PC], and the slaves represent devices such as the C-BOX. Connect the + and –for the master to [A] and [B]. Also at the end of the network, connect a 120Ω termination resistor.

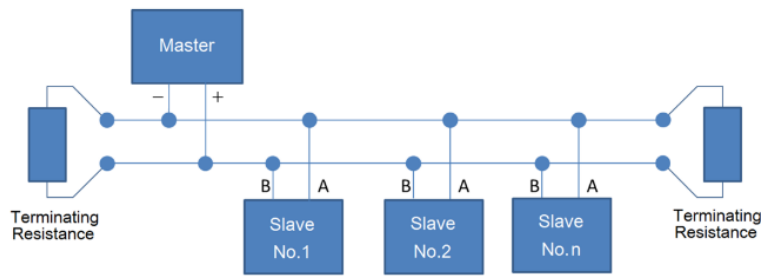

Figure 5-4-3. Connections of C-BOX in a Modbus 485 network

5-5. Operating

The Modbus operating mode is factory preset and can only be changed when operated in Modbus mode and connected to a PC. When powering the C-BOX it will always start up in Modbus mode. After 30s it will change to analog mode when set to analog mode. The analog mode and feature are not described in this manual.

5-6. Irradiance measurements



After powering the C-BOX all connected sensors automatically start measuring. For the MS-90 DNI sensor, the mirror will start to rotate and the detector voltage output will build up due to internal charging of a capacitor. This voltage will slowly decay to 0 if the irradiance conditions are 0 W/m² after approximately 1 minute.

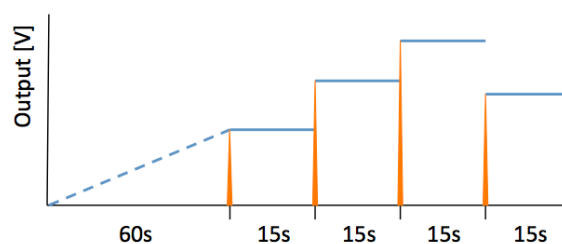

Figure 5-6-1. C-BOX analog output signal

The DNI measurements are taken every 15 seconds based on the rotation speed of the mirror. Global Irradiance (GHI) measurements are measured every 1 second.

For a system configured with MS-90 DNI and MS-80S pyranometer and operated in Modbus mode the three irradiance components (DNI, GHI, DHI) will be measured.

The pyranometer (GHI) signal is converted into irradiance based on the sensitivity figure which is factory preset. Hence the diffuse irradiance (DHI) is calculated based on the DNI and GHI.

$$\text{Irr}_{\text{DHI}} = \text{Irr}_{\text{GHI}} - (\text{Irr}_{\text{DNI}} \cdot \text{Cos } \theta)$$

- Irr_{DHI} = Calculated diffuse horizontal irradiance [W/m^2]
 Irr_{GHI} = Global Horizontal Irradiance [W/m^2]
 Irr_{DNI} = Direct Normal Irradiance [W/m^2]
 $\text{Cos } \theta$ = Solar zenith angle ($^\circ$)



For DNI values below $120 \text{ W}/\text{m}^2$ the diffuse irradiance (DHI) is equal to the global irradiance GHI. The second term (DNI) is set to zero.

6. Modbus communication

6-1. Communication

Table 6-1. C-BOX communication settings

C-Box	Function
Communication standard	RS-485
Protocol	Modbus Slave RTU
Communication speed	9600 Default
Data length	8bits
Node address	1 Default / can be changed with EKO software
Stop bit	1
Parity bit	None

Table 6-2. MS-80S communication settings

MS-80S	Function
Communication standard	RS-485
Protocol	Modbus Slave RTU
Communication speed	19200
Data length	8bits
Node address	Last 2 digits of serial number (100 in case ending at 00)
Parity bit	Even

Table 6-3. MS-80M communication settings

MS-80M	Function
Communication standard	RS-485
Protocol	Modbus Slave RTU
Communication speed	9600
Data length	8bits
Node address	1 Default
Parity bit	None

6-2. Registers

Table 6-2. C-BOX communication registers

Address	Label	Format	Description
0	MB_FW_VERSION	16 bit WORD	Firmware version
1	MB_SERIAL	16 bit WORD	Serial number
2	MB_SENSOR_MODEL	16 bit WORD	Sensor model
3	MB_BOARD_TEMPERATURE	16 bit WORD	PCB Temperature * 10
4	MB_MSX0	FLOAT	MS80S or M Global irradiance
6	MB_DNI	FLOAT	DNI
10	MB_NTC	FLOAT	MS80 Temperature
12	MB_DIFF	FLOAT	Diffuse
14	MB_TIMESTAMP	32 bit	Timestamp from GPS
18	MB_GPS_SATS	16 bit WORD	Amount of visible GPS satellites
22	MB_CF0	FLOAT	MS-80S or M calibration value
32	MB_CF5	FLOAT	MS-90 calibration value
34	MB_LAT	FLOAT	Latitude
36	MB_LON	FLOAT	Longitude
40	MB_ELEVATION	FLOAT	Sun elevation
42	MB_AZIMUTH	FLOAT	Sun azimuth

6-3. Software

The C-Box configuration software can be downloaded from the EKO-EU website (MS-90+ plus product page). Different measurement parameters can be displayed to verify the output parameters of the system. Sensor and communication settings can be made to setup the system. For connection to a PC an optional USB to 485-communication cable is required.

Communication

The C-box communication is through Modbus 485 RTU.

C-Box communication setting (Default)

RS-485 : Modbus RTU
Baud-rate : 9600
Node address : 1
Parity : None
Stop bit : 1

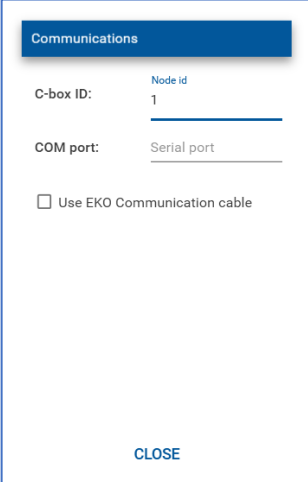

Table 6-3.1 Communications



Important Note: Any commercial USB / RS-485 communication can be used.

Data

When the GPS signal is available the latitude, Longitude and time information will be displayed. The solar Elevation and Azimuth position are calculated based on the GPS data. When the DNI sensor and MS-80S pyranometer is connected the GHI and DHI will be shown.

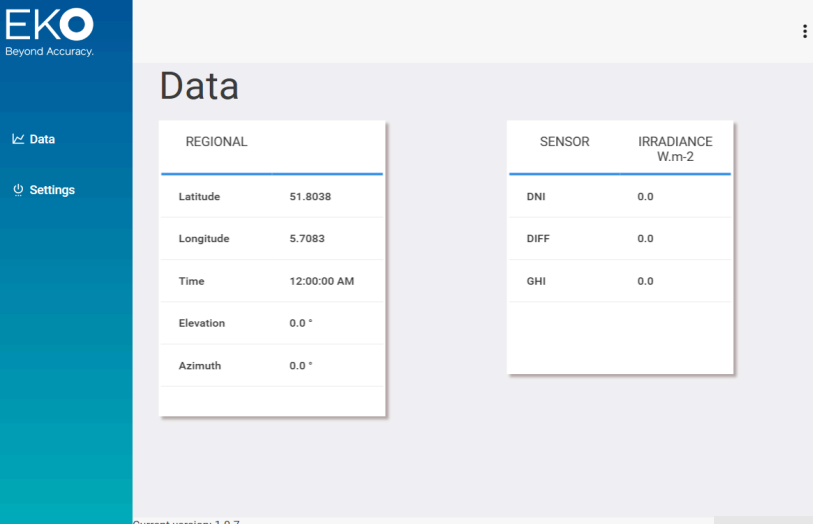

REGIONAL	
Latitude	51.8038
Longitude	5.7083
Time	12:00:00 AM
Elevation	0.0 °
Azimuth	0.0 °

SENSOR	IRRADIANCE W.m-2
DNI	0.0
DIFF	0.0
GHI	0.0

Table 6-3.1 Data

Settings

The setting menu can be used to change the sensitivity figure of the MS-90 DNI sensor. When the MS-90+ plus system is provided as a turn-key system, all sensor setting (MS-90, MS-80S) are made.

MS-80S node address is last 2 digits of MS-80S serial number.

SENSOR	CALIBRATION VALUE
C-BOX Node ID	Modbus node ID 1
MS90	Sensitivity $\mu\text{W}/\text{m}^2$ 0.000
GHI sensor	MS80S
Node Address	Sensor node address 0

Analog mode

Write to logger

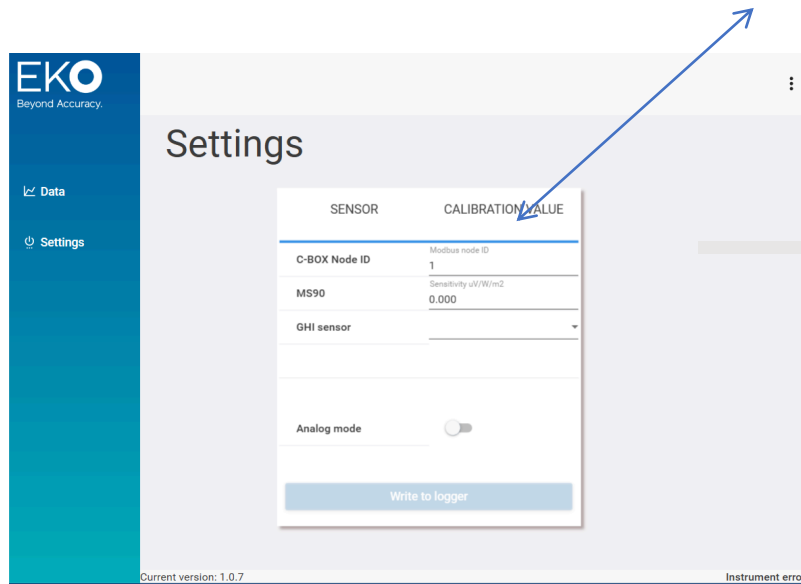

Table 6-3.2 Settings

7. Specification

7-1. Main Unit

Table 8-1. C-Box Specification

Characteristics	Details	
Input Signals	EKO MS-90 DNI sensor	Analog pulse 0 to 2V
	EKO MS-80S/M Pyranometer	Modbus 485 RTU
Communication Method	RS-485 (Modbus RTU)	
Operating Temperature Range	-40 to +80°C	
Power Supply	24VDC (Note: Supply voltage critical for MS-90)	
Average Power Consumption	0.5W	
Dimensions (L / W / H)	125 x 60 x 80 mm	
Weight (kg)	0.5	
Ingress protection	IP 65	

Table 8-2. C-Box MS-90 Plus+ system Specifications

Characteristics	Details	
Input parameters	EKO MS-90 DNI sensor	DNI
	EKO MS-80S/M Pyranometer	GHI
Output parameters	DNI / GHI / DHI (Meta data T, RH, Tilt, Long / Lat position, Solar Position, Time)	
Sampling	1s (15s DNI)	
Irradiance range DNI (Measured)	0 – 1600 W/m ²	
Irradiance range GHI (Measured)	0 – 1600W/m ²	
Irradiance range DHI (Calculated)	0 – 500 W/m ² (DHI = GHI when DNI < 120 W/m ²)	

7-2. Dimensions

<https://www.rose-systemtechnik.com/pim/assets/M01081306.pdf>

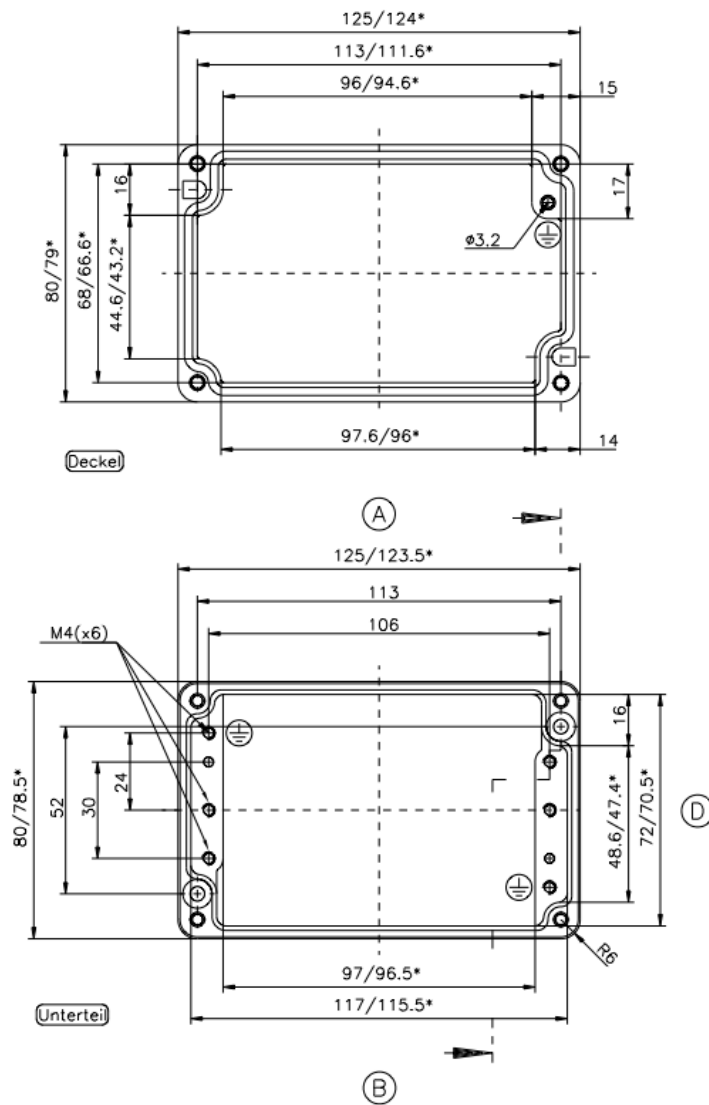

Appendix

Appendix -A. Wiring table C-Box

Table appendix Wiring table

Terminals	Function
1. Shield	Not connected
2. Shield	Not connected
3. 0V	MS-80S (White)
4. 24 VDC Out	MS-80S (Brown)
5. Modbus B	MS-80S (Black)
6. Modbus A	MS-80S (Blue)
7. Modbus GND	MS-80S (Grey)
8. Reserved	No used
9. MS-80 (+) Analog	Disabled
10 MS-80 (-) Analog	Disabled
11. MS-90 DNI (+)	MS-90 (Brown)
12. MS-90 DNI (-)	MS-90 (White)
13. 0V	No used
14. 0V	No used
15. 12VDC Out MS-90	MS-90 (Blue)
16. 0VDC Out MS-90	MS-90 (Black)



EKO Asia, Oceania

1-21-8 Hatagaya,
Shibuya-ku, Tokyo
151-0072 Japan
P. +81.3.3469.6711
F. +81.3.3469.6719
info@eko-asia.com
www.eko.co.jp

EKO North America

95 South Market Street,
Suite 300, San Jose,
CA 95113, USA
P. +1-408-977-7751
F. +1-408-977-7741
info@eko-usa.com
www.eko-usa.com

**EKO Europe,
Middle East, Africa,
South America**

Lulofsstraat 55, Unit 28,
2521 AL, Den Haag,
The Netherlands
P. +31 (0)70 3050117
F. +31 (0)70 3840607
info@eko-eu.com
www.eko-eu.com