

Thank you for purchasing an EKO UV Radiometer. This Quick Start Guide provides basic instructions to help you set up and get started. Please see the **Instruction Manual** for more detailed information about this product.

### Product Warranty

Your UV Radiometer comes with a 2-year warranty. For further information, warranty terms and conditions, please consult the **Instruction Manual**, EKO Instruments, or your distributor. **Please Note:** All of our products are tested to ensure that they meet their published specifications. The warranty included in the conditions of delivery is valid only if the product has been installed and used in accordance with the instructions provided in the **Instruction Manual**.

# 3 Installation

- 1 Mount the UV Radiometer on the Installation Base
- 2 Level the UV Radiometer
- 3 Fasten the UV Radiometer to the Installation Base

**Horizontal surface:**  
Level the UV Radiometer by adjusting the leveling screws.

**Inclined surface:**  
Install on an inclined surface after leveling the UV Radiometer by adjusting the leveling screws on a horizontal surface.

⚠ For installation do not remove the leveling screws

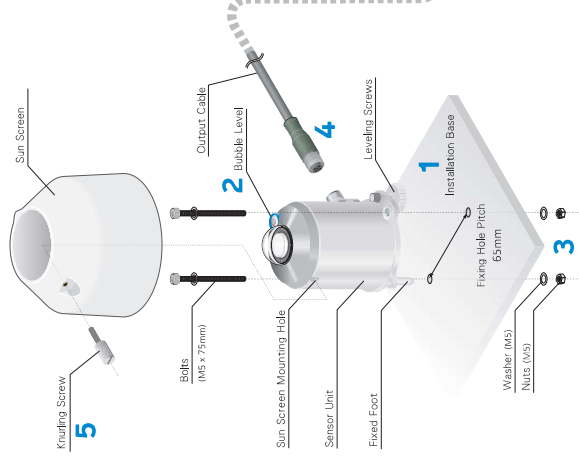

# 4

## Securely Insert the Output Cable Into the Sensor Unit

Insert the output cable into the connector port on the back of the sensor unit and tighten it all the way. Push the connector in, and check to make sure the screw is tight.

⚠ If the connection is loose, water can enter the unit and cause it to malfunction.

- Secure the length of the cable to avoid it from being pulled loose.
- Connect the frame ground shielded wire to prevent electrical shocks

## 5 Attach the Sun Screen

Place the sun screen in the proper position; insert the tab inside the sun screen to the groove on the sensor unit.

Fasten the knurling screw, and check that it is secure.

## 6 Wiring

Connect the output cable to each terminal

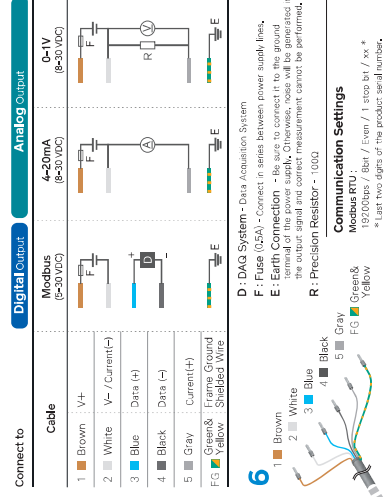

### Approximate Output Values

Conditions	Cloudy	Partly Cloudy	Clear
Modul	MS-10S	MS-11S	MS-10S
Irradiance [W/m <sup>2</sup> ]	< 1.5	< 0.2	> 15
4-20mA Output [mA]	< 5.6	< 4.3	> 5.6
0-1V Output [V]	< 0.1	< 0.02	> 0.2

# 4 Measurement & Maintenance

## Measurement Range

Set the measurement range on the measuring instrument based on the output range.

Output Range	0-1V Output	4-20mA Output	Digital Output Specification
Modul	0 to 1 [V]	4 to 20 [mA]	Modbus RTU Electrical Specification
Measurement Range	0 to 1 [V]	4 to 20 [mA]	EIA RS-485

## Calculate UV Irradiance

Using the following formulas, radiometer output value can be converted into irradiance.

**0-1V Output**

$$I [W/m^2] = E [V] \times K [W/m^2/V]$$

**4-20mA Output**

$$I [W/m^2] = (I_{out} [mA] - 4) \times K [W/m^2/mA]$$

**Digital Output**

$$I [W/m^2] = (I_{out} [mV] - 4) \times K [W/m^2/mV]$$

Conversion is not necessary as the output can be obtained as irradiance in W/m<sup>2</sup>.

## 2 Location & Setup Conditions

- Select a location with free horizon, without any obstructions or light reflections throughout the day.
- Place the radiometer with the Cable Connector facing the nearest pole.
- Orientate the Fixing Holes on the Installation Base.

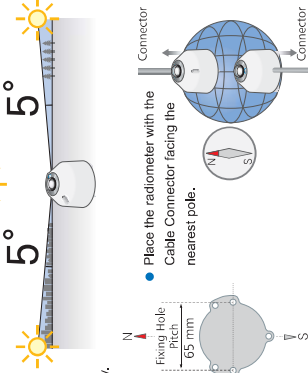

## 1 Required Tools

Please prepare these tools on your own to aid in the installation process.

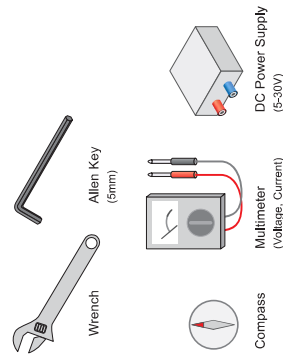

## 1 Package Contents

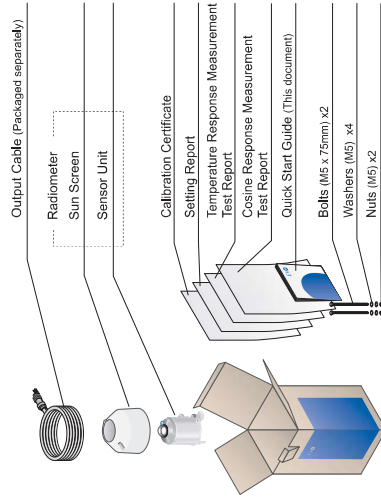

- Please check the package contents. If any part is missing or damaged, please contact EKO or your EKO distributor.
- Please download the instruction manual from the EKO website.
- We recommend that you keep the original packaging for return shipping in case of recalibration or repair.

### Handling Caution

⚠ Always hold the radiometer from the bottom when carrying. Do not hold the sun screen part as the sensor unit may drop.



## Recalibration & Desiccant Replacement

To maintain the highest levels of measurement accuracy, we recommend periodic recalibration of your product (every 2 years for the MS-10S and MS-11S). Please contact EKO Instruments for more information about our Recalibration Services. Desiccant replacement is performed during factory recalibration. Attempting to replace the desiccant yourself may void the product warranty.

## Periodic Maintenance

- Bubble Level:** Check if the bubble is within the center ring. Readjust if necessary.
- Glass Dome:** Keep the glass dome clean by wiping with a soft cloth and alcohol based cleaning solution. Make sure there are no scratches on the glass dome.
- Connector & Cable Condition:** Check and make sure the connector is connected securely and the cable is not damaged. Also check the cable is fixed.



# Specifications

	MS-10S, MS-11S
a : Fixing Hole Pitch	65 mm
b : Width	∅96 mm
c : Height	101.5 mm
Mass	0.45 kg
Operating Temperature	-40 to 80 °C
Input Power	Modbus : 4.75 to 30 V DC 0-1V/4-20mA : 8 to 30 V
Power Consumption	Digital Output : < 0.2 W Analog Output : < 0.7 W

# Quick Start Guide Hibi Software



## Meet Hibi

Hibi, available for Windows from the EKO website, is a free to download programme designed to help you get the most from your sensor. Use Hibi to visualise detection signals, change settings, set communication parameters, check the status of your pyranometer, and rapidly troubleshoot any issues.

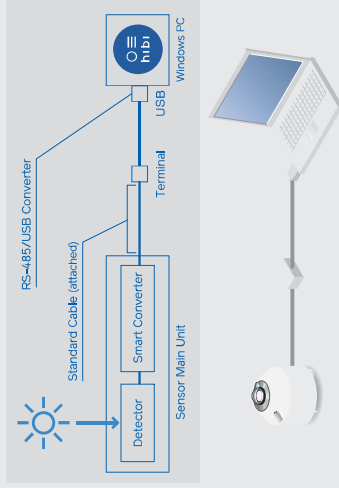

## What can Hibi do?

- **Change your sensor's signal converter settings**  
Manage the communication protocol and output signal settings.
- **Realtime display of measurement values and sensor conditions**  
Get instant, easy to read measurement values and live information on the condition of your sensor (temperature, humidity, tilt).
- **Record measurement data**  
Measurement data can be recorded and output to CSV (comma delimited).

# 1 Preparation

## 1 Download

EKO INSTRUMENTS

Download Hibi from the MS-10S, MS-11S, MS-12S and MS-13S product page on the EKO website.

## 2 Install

Execute the installer file (.exe) and install Hibi on your PC.

## 3 Connect sensor and PC using cable

Connect 5 cable terminals as shown in the Communication Cable Wiring Diagram.

### Communication Cable Wiring Diagram

How to connect to PC when using general purpose RS-485/USB cable.

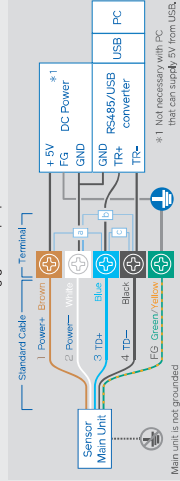

a : Pull-up resistor 6800 Ω. b : Pull-down resistor 6800 Ω. c : Terminating resistor 120Ω. Depending on the converter cable type and specifications, pull-up/pull-down resistors and a terminating resistor are required. However, with the optional EKO Converter cable, additional resistors are not necessary.

## 4 Start up Hibi

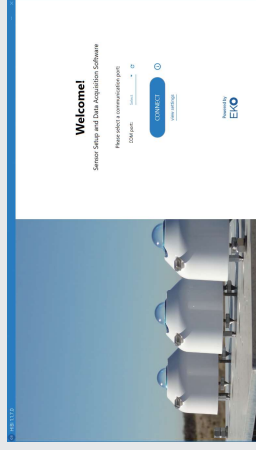

## 5 Reconnect Cable

To automatically connect, remove the cable from the sensor, click CONNECT, then reconnect the cable within 10 seconds.

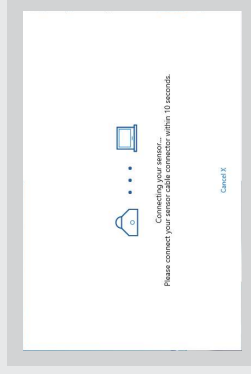

Hibi cannot operate without an established connection to the sensor.

# 2 Operation

Once the connection between Hibi and the sensor is established, the Hibi dashboard will automatically load. See manual for more detailed information.

## 1 Dashboard

Current sensor output value is displayed in realtime.

- a : Irradiance (Instantaneous Value)
- b : Internal Temperature
- c : Internal Humidity
- d : Tilt Angle
- e : Irradiance Graph
- f : Data Logging Setting



## 2 Settings

- COMMUNICATION : Communication settings can be changed.
- SENSOR INFORMATION : Sensor information, such as serial number and calibration value can be viewed.
- OUTPUT : Output Signal (4-20mA / 0-1V) (Default: 4-20mA). Output signal can be changed.
- TEMPERATURE : Temperature Unit [C / F / K] (Default: C)
- SENSOR POSITION : Tilt sensor zero-point adjustment
- DATA FILES : Save location of measurement data and setting data

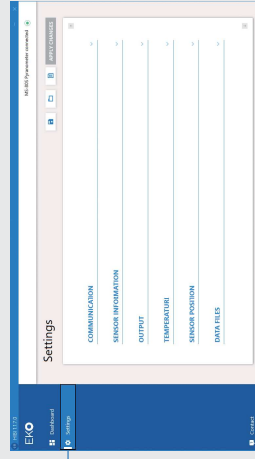

Please refer to the APPENDIX (Communication Specifications) of the instruction manual for Modbus communication settings.

# EKO INSTRUMENTS



**EKO Japan, Asia, Middle East, Africa, South America**  
P: +81 (0) 3469 6711

**EKO Europe, Middle East, Africa, South America**  
P: +1 408 977 7751

**EKO North America**  
P: +1 408 977 7751

**EKO Instruments**  
P: +31 (0) 70 305 0117

**eko-instruments.com**

Specifications could be changed without notice. © EKO INSTRUMENTS CO., LTD. OCS-MS-US\_19s2409E

